

Phonics

Letter-Sound Correspondence Cards – Initial

P.LSC-I.1

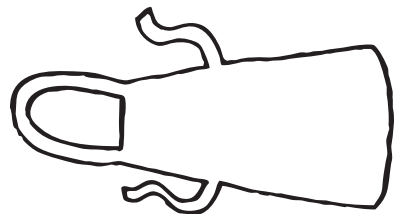
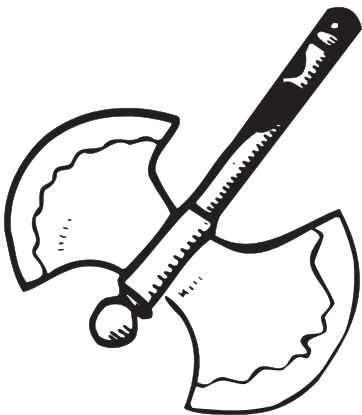
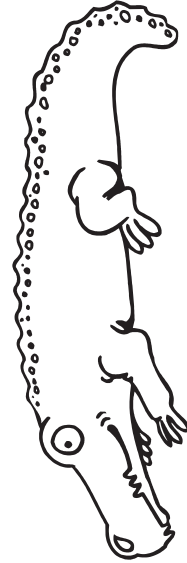
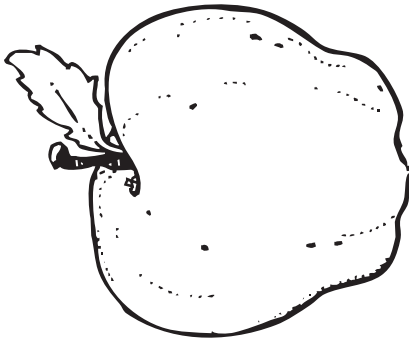
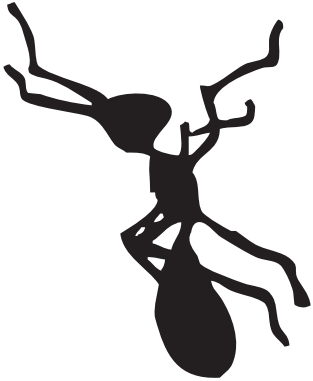

ant, apple, alligator, ax, ape, apron



P.LSC-I.2

Letter-Sound Correspondence Cards – Initial

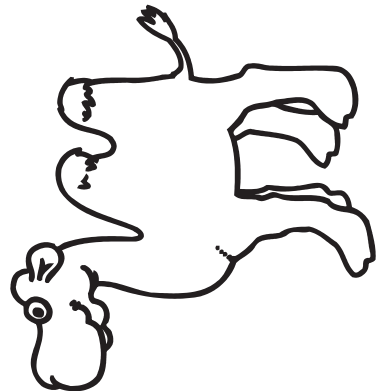
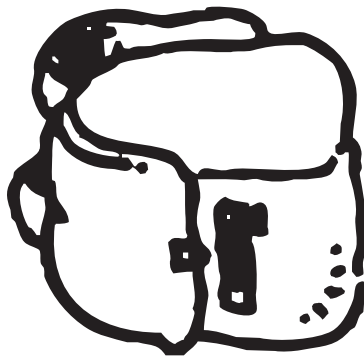
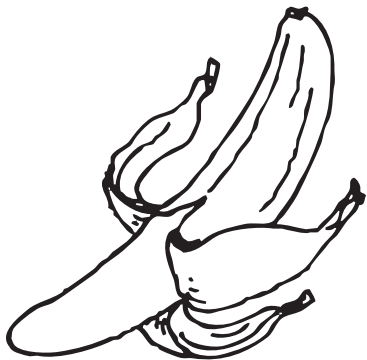
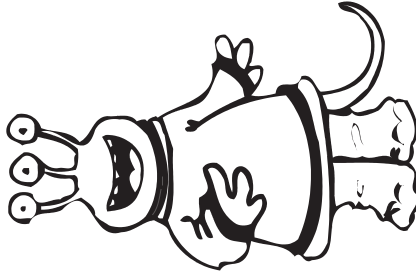
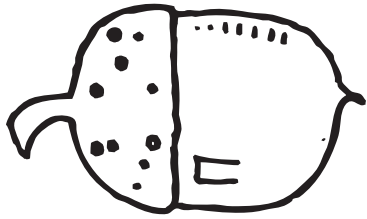

acorn, alien, beach, banana, backpack, camel



Phonics

Letter-Sound Correspondence Cards – Initial

P.LSC-I.3

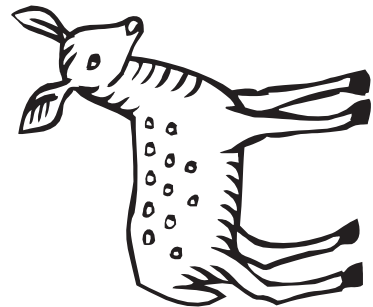
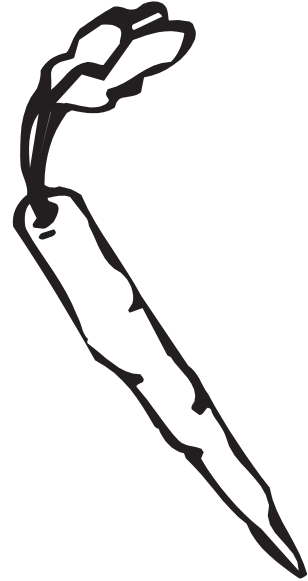
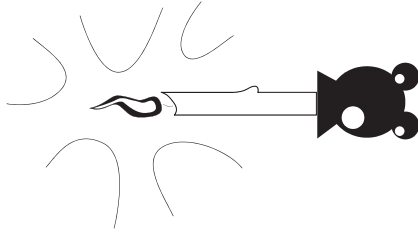

cane, candle, carrot, doughnut, dragon, deer



P.LSC-I.4

Letter-Sound Correspondence Cards – Initial

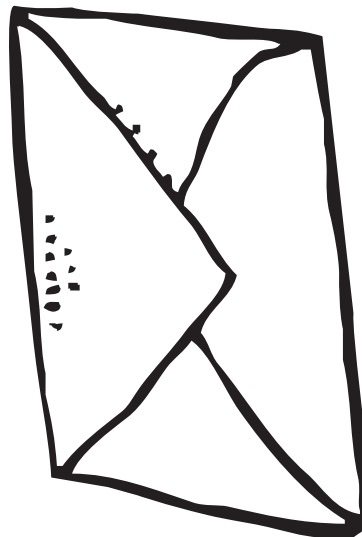
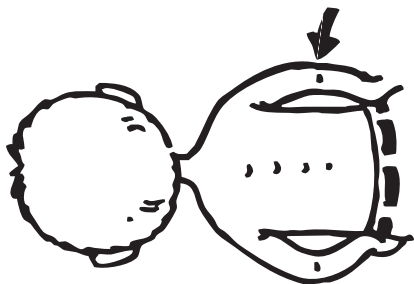
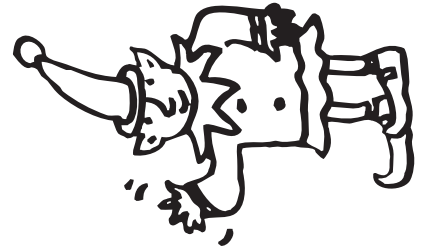
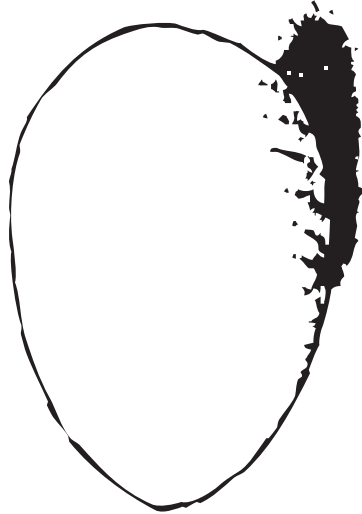
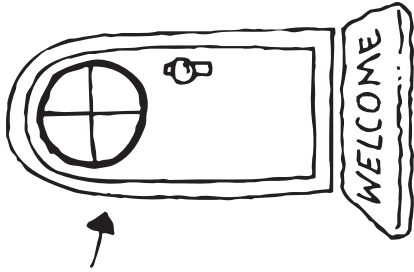

2+2 = 4

door, egg, elf, elbow, envelope, equal



Phonics

Letter-Sound Correspondence Cards – Initial

P.LSC-I.5

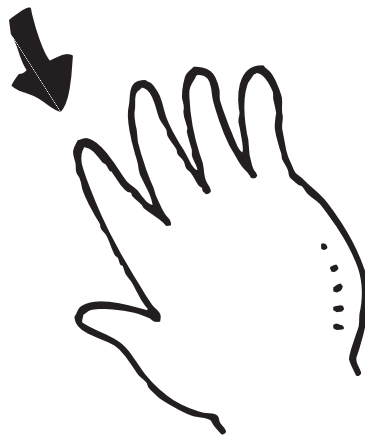
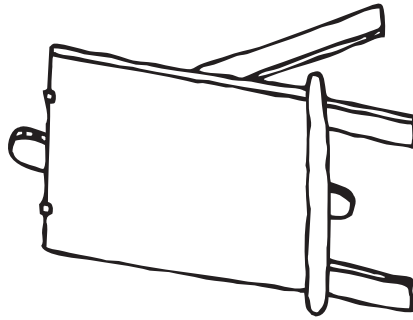

eagle, easel, eat, four, finger, feather



P.LSC-I.6

Letter-Sound Correspondence Cards – Initial

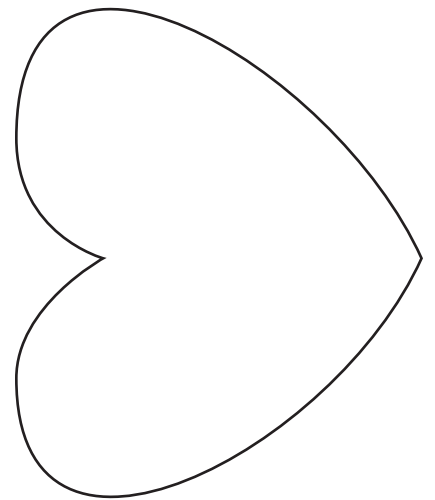
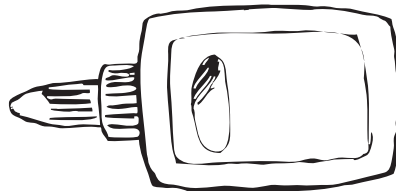
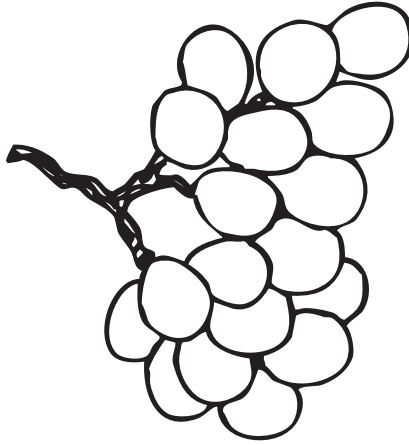
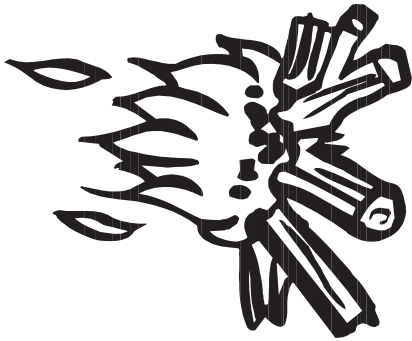

fire, grapes, guitar, gold, glue, heart



Phonics

Letter-Sound Correspondence Cards – Initial

P.LSC-I.7

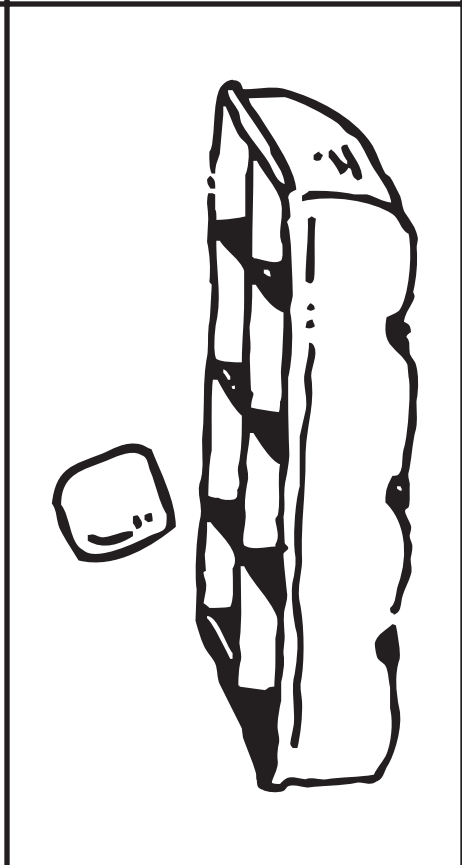
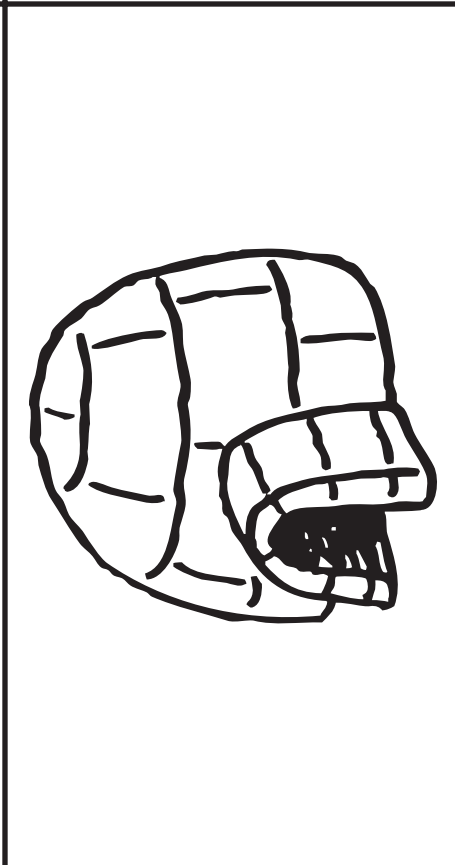
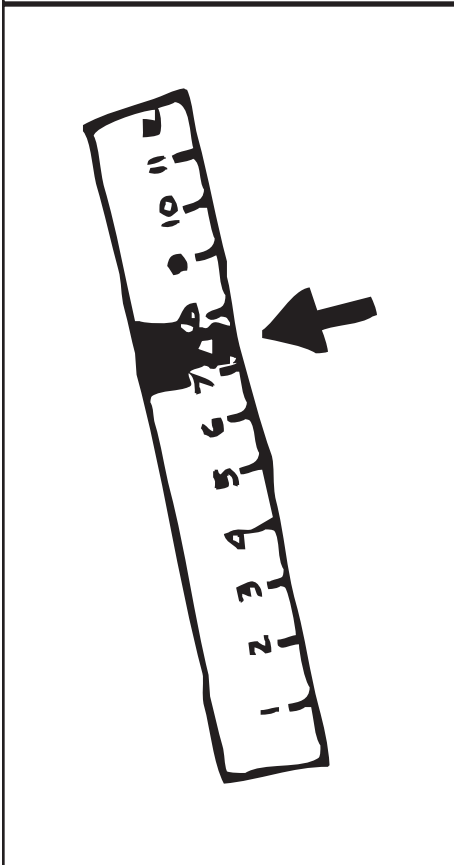
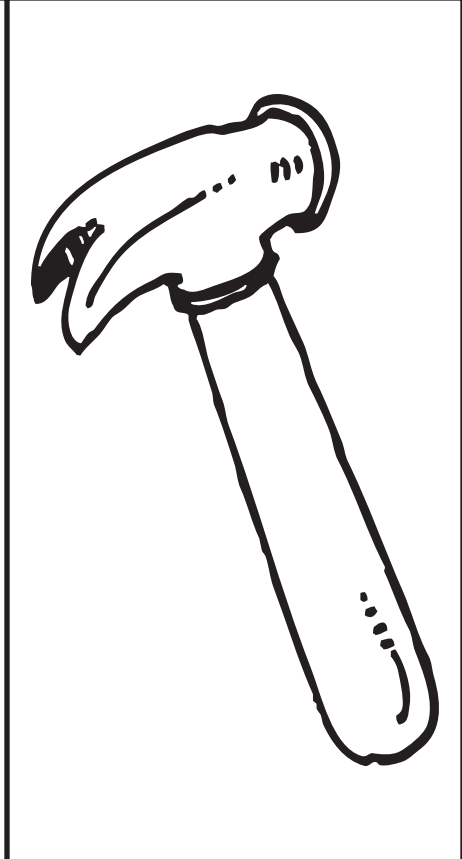
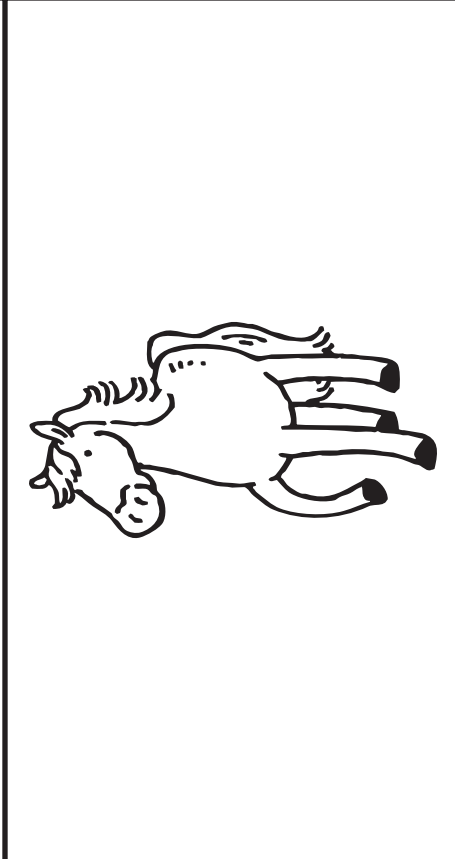

hippopotamus, horse, hammer, inch, igloo, ice



P.LSC-I.8

Letter-Sound Correspondence Cards – Initial

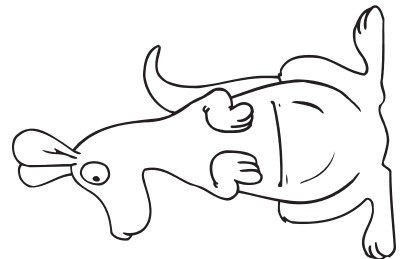
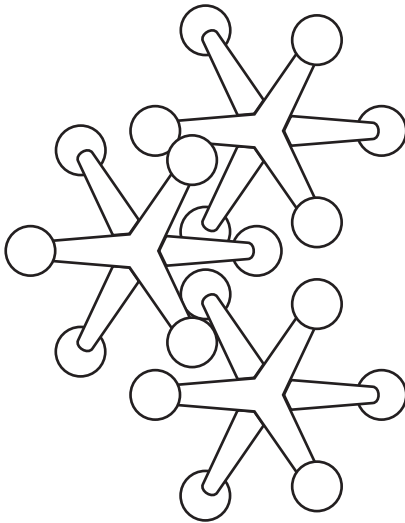
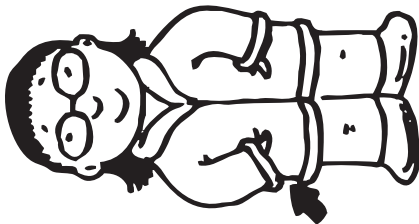
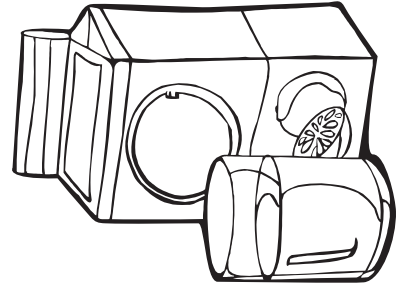
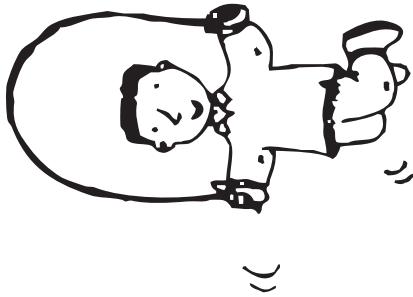
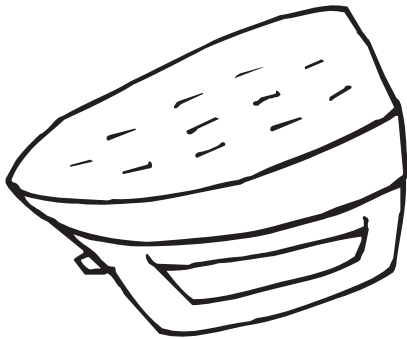

iron, jump, juice, jacket, jacks, kangaroo



Phonics

Letter-Sound Correspondence Cards – Initial

P.LSC-I.9

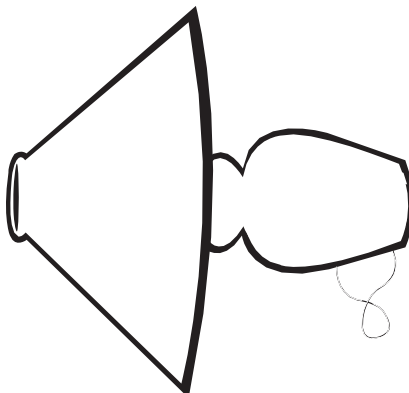
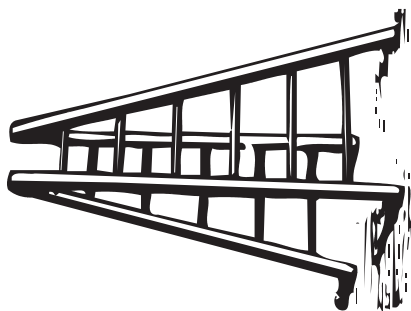
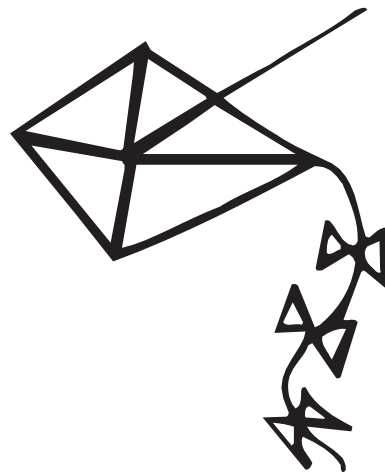
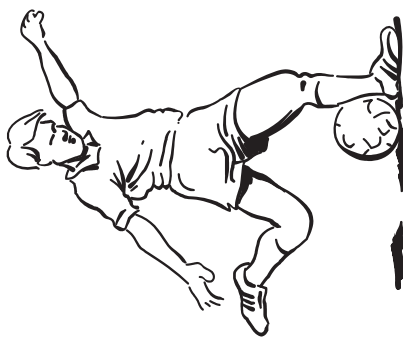
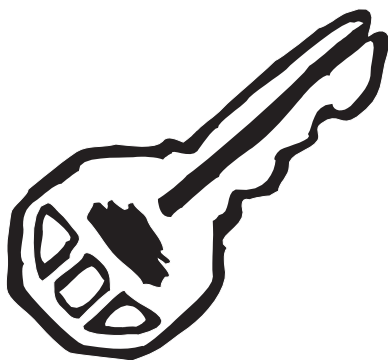

key, kick, kite, ladder, lamp, lion



P.LSC-I.10

Letter-Sound Correspondence Cards – Initial

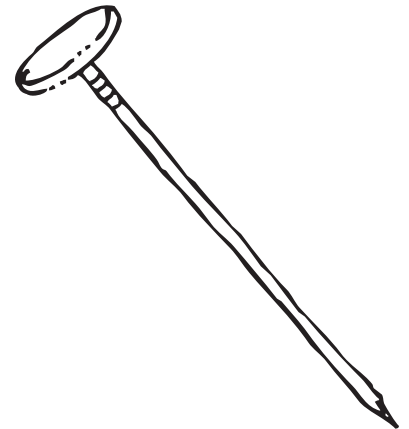
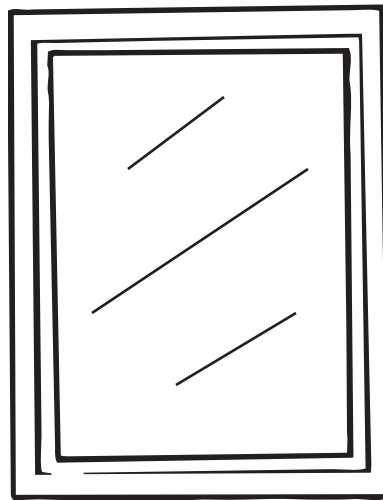
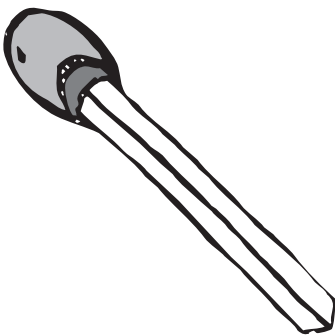
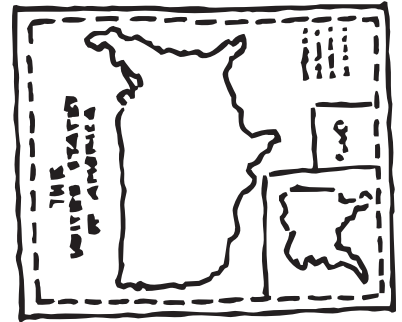
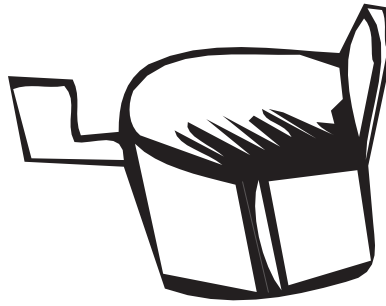
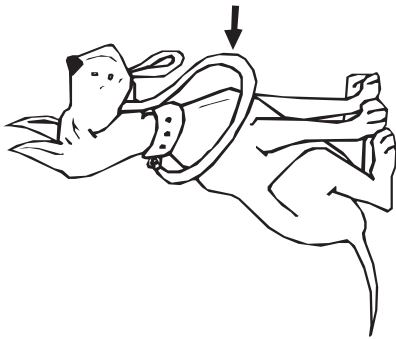

leash, mailbox, map, match, mirror, nail



Phonics

Letter-Sound Correspondence Cards – Initial

P.LSC-I.1.1

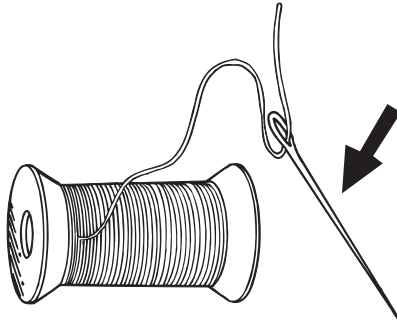
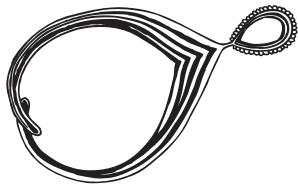

necklace, needle, nurse, octopus, ox, olive



P.LSC-I.12

Letter-Sound Correspondence Cards – Initial

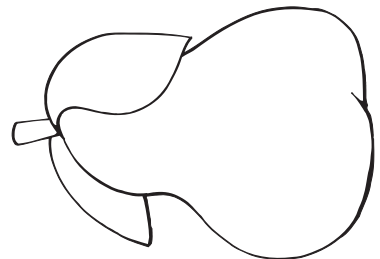
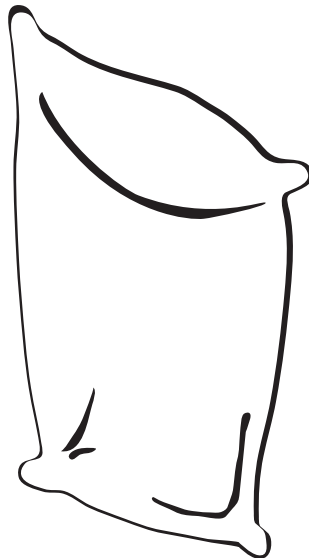
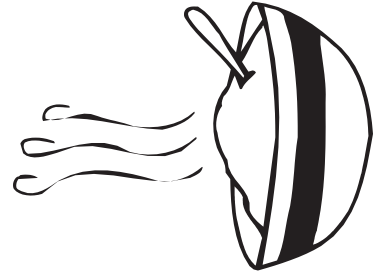
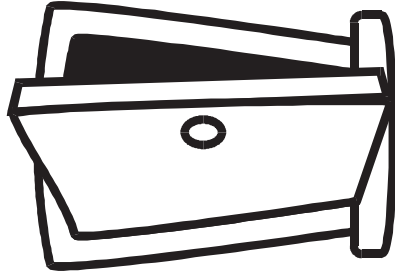

ostrich, open, oatmeal, pretzel, pillow, pear



Phonics

Letter-Sound Correspondence Cards – Initial

P.LSC-I.13

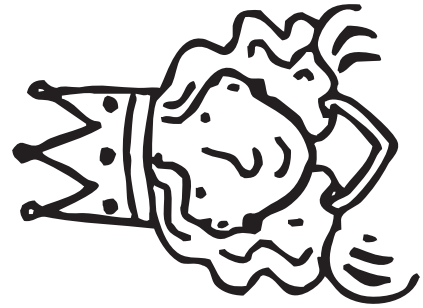
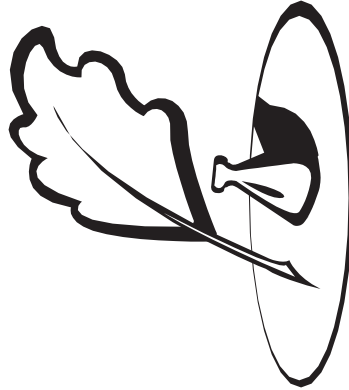
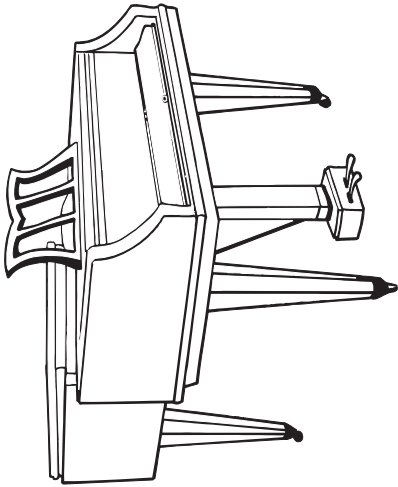

piano, quill, queen, question, quarter, rabbit



P.LSC-I.14

Letter-Sound Correspondence Cards – Initial

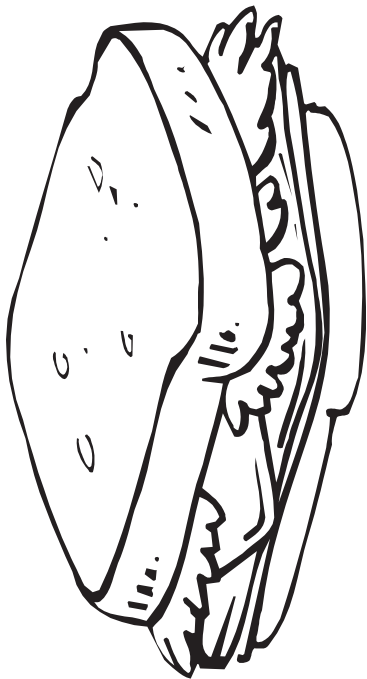
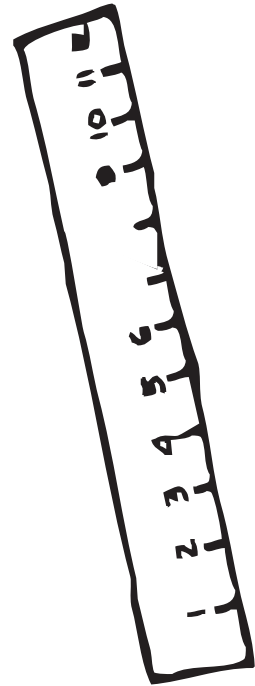
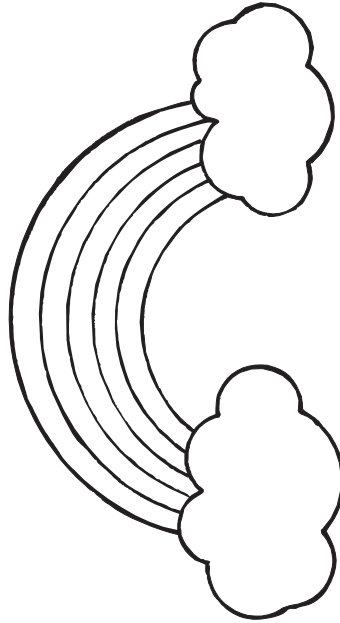
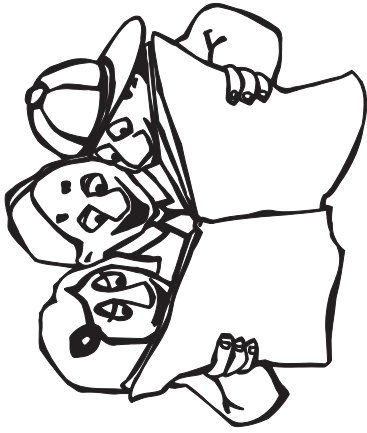

read, rainbow, ruler, sandwich, saw, seven



Phonics

Letter-Sound Correspondence Cards – Initial

P.LSC-I.15

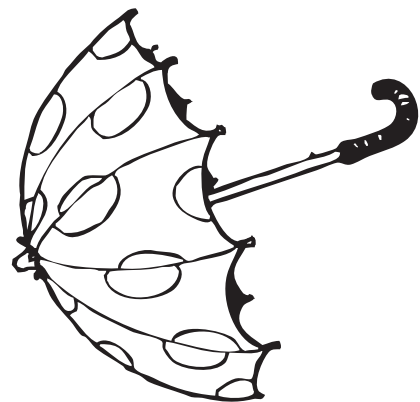
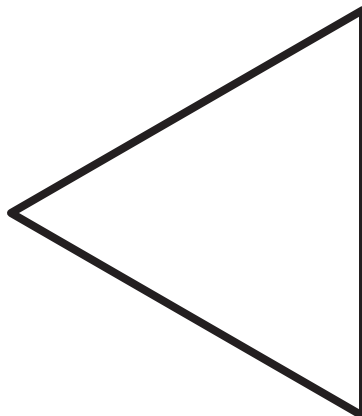
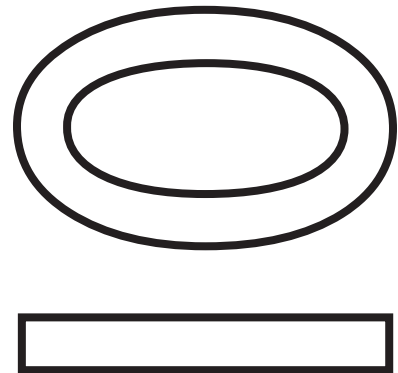
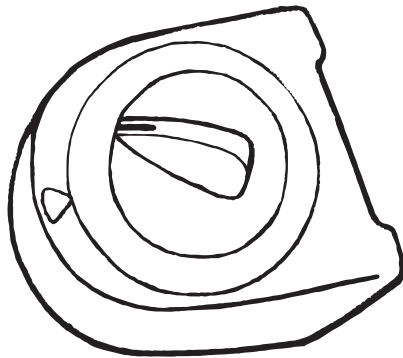

snake, timer, ten, tire, triangle, umbrella



P.LSC-I.16

Letter-Sound Correspondence Cards – Initial

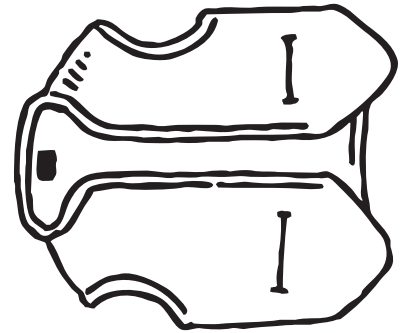
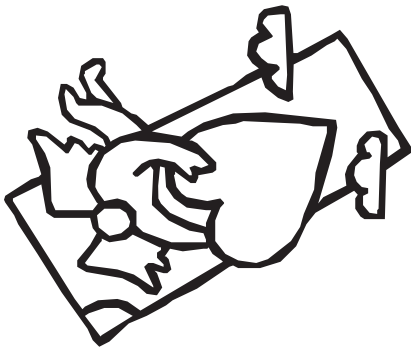
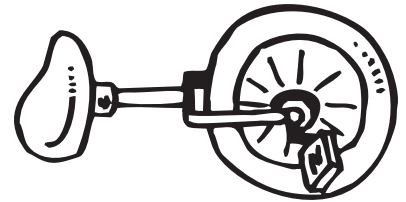
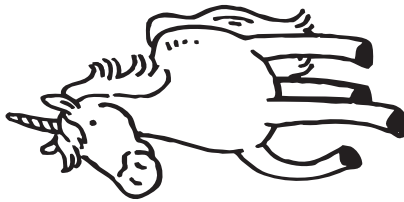

umpire, unicorn, unicycle, valentine, vacuum, vest



Phonics

Letter-Sound Correspondence Cards – Initial

P.LSC-I.17

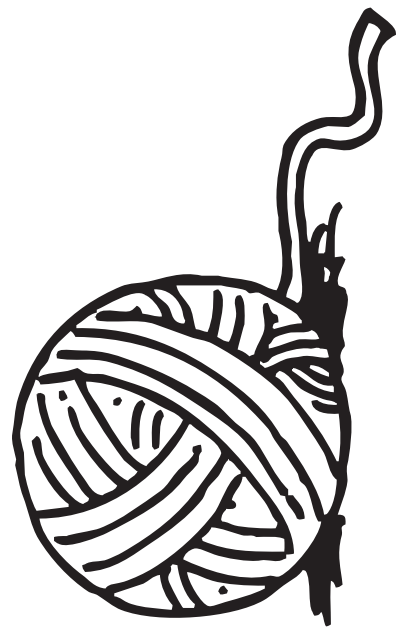
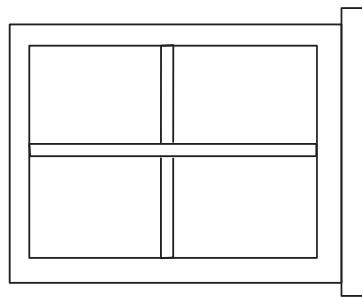
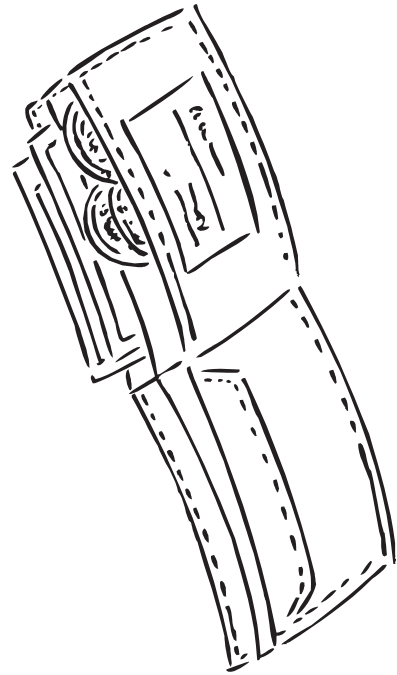
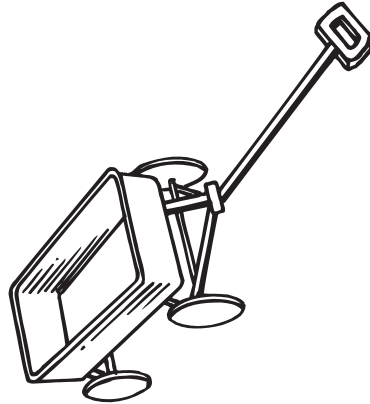
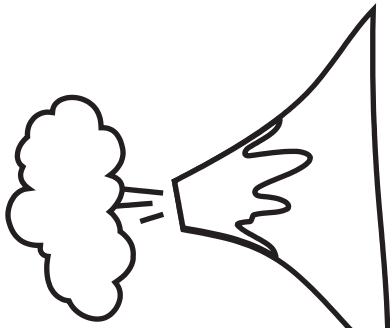

volcano, wagon, wallet, watch, window, yarn



P.LSC-I.18

Letter-Sound Correspondence Cards – Initial

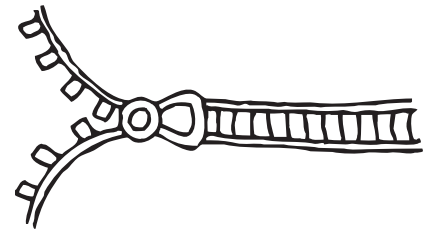
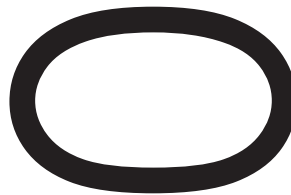
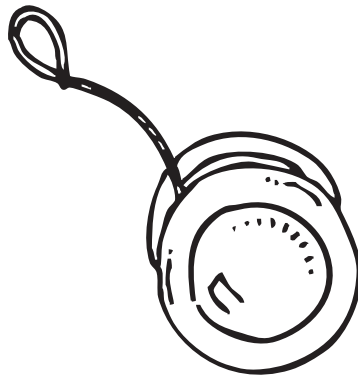
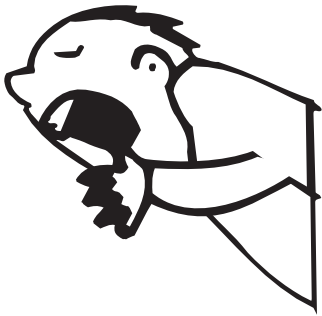

yawn, yo-yo, yak, zebra, zero, zipper



Phonics

Letter-Sound Correspondence Cards – Initial

P.LSC-I.19

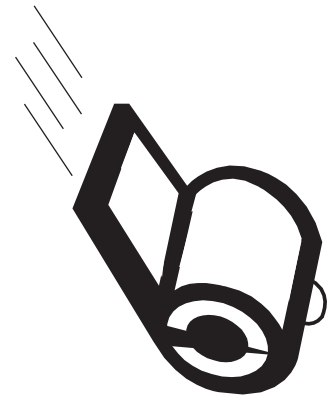
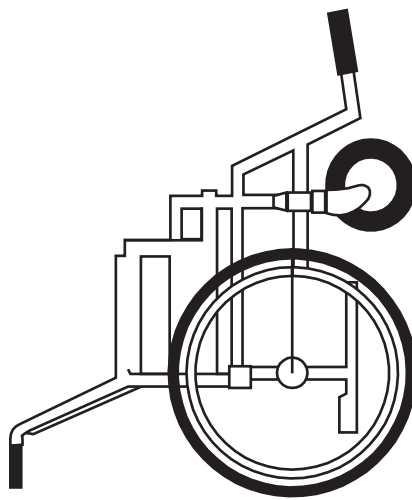
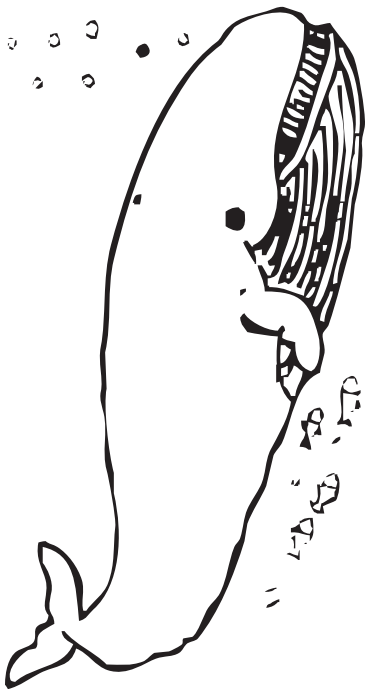
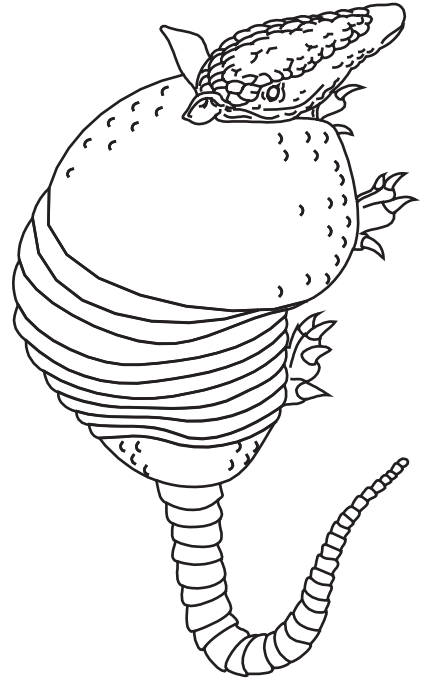

zoo, arm, armadillo, whale, wheelchair, whistle



P.LSC-I.20

Letter-Sound Correspondence Cards – Initial

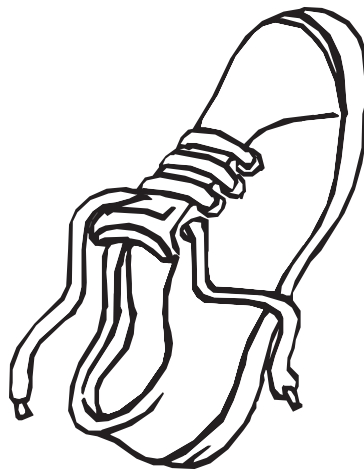
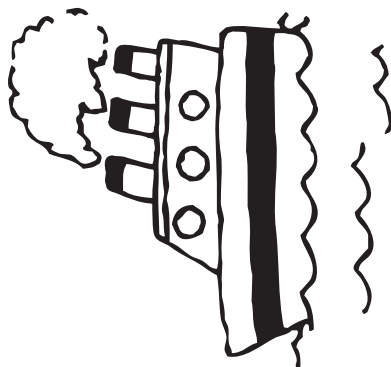
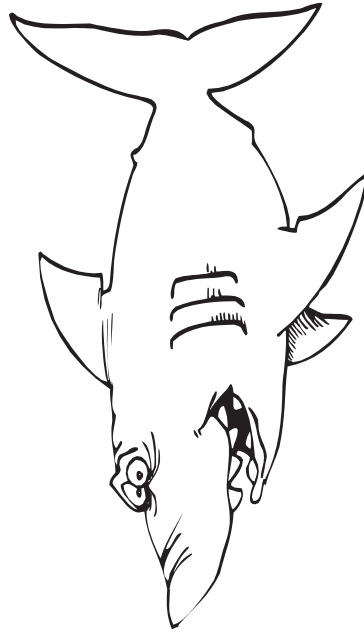
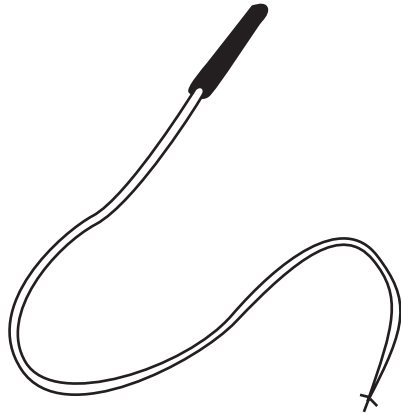

whip, shark, shell, ship, shoe, thermometer



Phonics

Letter-Sound Correspondence Cards – Initial

P.LSC-I.2I

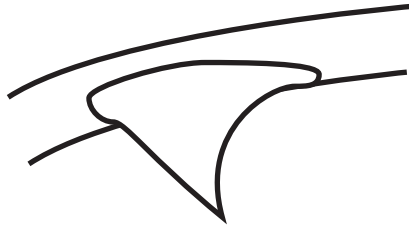
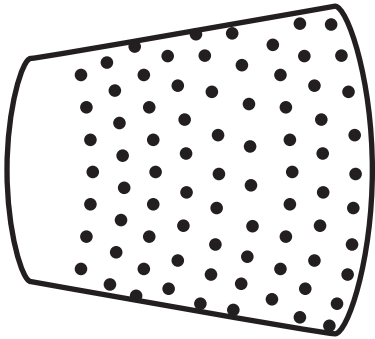

30

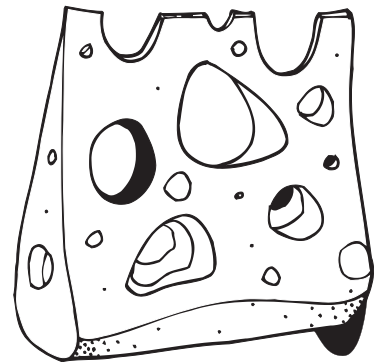
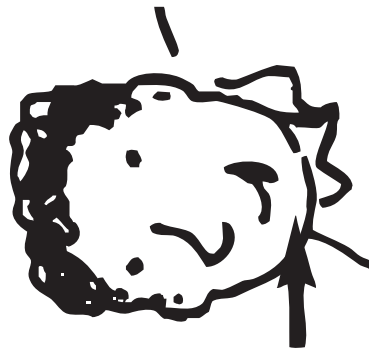
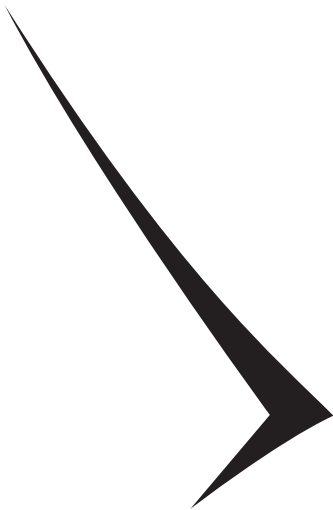

thimble, thorn, thirty, check, chin, cheese



P.LSC-I.22

Letter-Sound Correspondence Cards – Initial

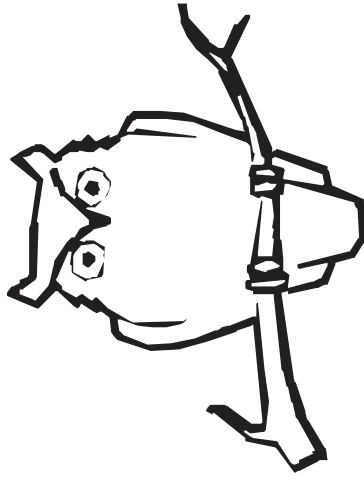
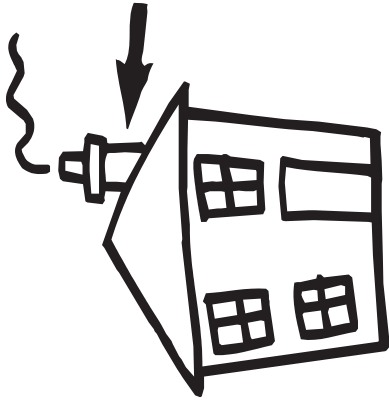

chimney, owl, ouch

